

LCD MOUDULE SPECIFICATION FOR APPROVAL	DATE	10/12/03
	VER.	1.0
JHD12864E	PAGE	1

# CONTENTS

1.	FEATURES .....	4
2.	MECHANICAL SPEC .....	4
3.	ABSOLUTE MAXIMUM RATING .....	5
4.	ELECTRICAL CHARACTERISTICS .....	5
5.	ELECTRO-OPTICAL CHARACTERISTICS .....	6
6.	QC/QA PROCEDURE .....	7
7.	RELIABILITY .....	8
8.	BLOCK DIAGRAM .....	9
9.	POWER SUPPLY .....	9
10.	TIMIING DIAGRAM .....	10
11.	AC CHARACTERISTICS.....	11
12.	INSTRUCTION SET .....	12
13.	HANDLING PRECAUTION.....	13-15
14.	EXTERNAL DIMENSION .....	16
15.	INTERFACE .....	17

LCD MOUDULE SPECIFICATION FOR APPROVAL	DATE	10/12/03
	VER.	1.0
JHD12864E	PAGE	2

## 1. FEATURES

- Display construction..... 128\*64 DOTS
- Display mode ..... STN / Yellow Green
- Display type ..... Positive Tranflective
- Viewing direction..... 6 o' clock
- Operating temperature..... Indoor
- Driving voltage..... Single power
- Driving method..... 1/64 duty, 1/9 bias
- Type..... COB (Chip On Board)
- Number of data line..... 8-bit parallel
- Connector..... Pin

## 2. MECHANICAL DATA

ITEM		WIDTH	HEIGHT	THICKNESS	UNIT
Module size		93.0	70.0	12.7 (MAX)	mm
Viewing area		70.7	38.8	-	mm
Dot	Size	0.48	0.48	-	mm
	Pitch	0.52	0.52	-	mm
Diameter of mounting hole		2.7			mm
Weight		About 50			g

LCD MODULE SPECIFICATION FOR APPROVAL	DATE	10/12/03
	VER.	1.0
JHD12864E	PAGE	3

### 3. ABSOLUTE MAXIMUM RATINGS

Characteristic	Symbol	Value	Unit	Note
Operating voltage	$V_{DD}$	-0.3 to +7.0	V	(1)
Supply voltage	$V_{EE}$	$V_{DD}-19.0$ to $V_{DD}+0.3$	V	(4)
Driver supply voltage	$V_B$	-0.3 to $V_{DD}+0.3$	V	(1), (3)
	$V_{LCD}$	$V_{EE}-0.3$ to $V_{DD}+0.3$	V	(2)
Operating temperature	$T_{OPR}$	-30 to +85	°C	
Storage temperature	$T_{STG}$	-55 to +125	°C	

### 4. ELECTRICAL CHARACTERISTICS

( $V_{DD} = +5V \pm 10\%$ ,  $V_{SS} = 0V$ ,  $V_{DD}-V_{EE} = 8$  to  $17V$ ,  $T_a = -30$  to  $+85^\circ C$ )

Characteristic	Symbol	Condition	Min	Typ	Max	Unit	Note
Input high voltage	$V_{IH1}$	–	$0.7V_{DD}$	–	$V_{DD}$	V	(1)
	$V_{IH2}$	–	2.0	–	$V_{DD}$	V	(2)
Input low voltage	$V_{IL1}$	–	0	–	$0.3V_{DD}$	V	(1)
	$V_{IL2}$	–	0	–	0.8	V	(2)
Output high voltage	$V_{OH}$	$I_{OH} = -200\mu A$	2.4	–	–	V	(3)
Output low voltage	$V_{OL}$	$I_{OL} = 1.6mA$	–	–	0.4	V	(3)
Input leakage current	$I_{LKG}$	$V_{IN} = V_{SS} - V_{DD}$	-1.0	–	1.0	$\mu A$	(4)
Three-state(off) input current	$I_{TSL}$	$V_{IN} = V_{SS} - V_{DD}$	-5.0	–	5.0	$\mu A$	(5)
Driver input leakage current	$I_{DIL}$	$V_{IN} = V_{EE} - V_{DD}$	-2.0	–	2.0	$\mu A$	(6)
Operating current	$I_{DD1}$	During display	–	–	100	$\mu A$	(7)
	$I_{DD2}$	During access Access cycle = 1MHz	–	–	500	$\mu A$	(7)
On resistance	$R_{ON}$	$V_{DD}-V_{EE} = 15V$ $I_{LOAD} = \pm 0.1mA$	–	–	7.5	$K\Omega$	(8)

LCD MOUDULE SPECIFICATION FOR APPROVAL	DATE	10/12/03
	VER.	1.0
JHD12864E	PAGE	4

## 5. ELECTRO-OPTICAL CHARACTERISTICS

ITEM	SYMBOL	CONDITION	MIN.	TYP.	MAX.	UNIT	NOTE
Contrast ratio	K	$\phi=0$	1.4	4	-	-	1
Response time (rise)	Tr	$\phi=1$	-	130	-	ms	2
Response time (fall)	Tf	$\phi=2$	-	130	-	ms	2
Viewing angle	$\phi$	$K \geq 1.4$	10 -- +30			deg.	3
	$\theta$		-30 -- +30				

### Note 1: Definition of Contrast Ratio "K"

$$K = \frac{\text{Brightness of non-selected segment(A)}}{\text{Brightness of selected segment(B)}}$$

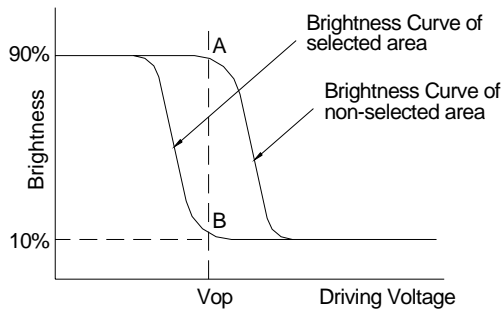

### Note 2: Definition of Optical Response Time

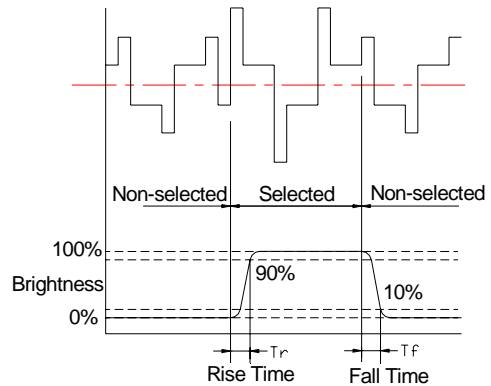

### Note 3: Definition of Viewing Angle

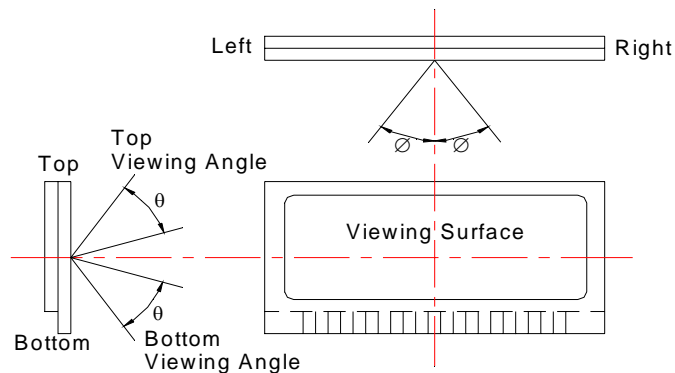

Please select either top or bottom viewing angle

LCD MOUDLE SPECIFICATION FOR APPROVAL	DATE	10/12/03
	VER.	1.0
JHD12864E	PAGE	5

## 6. QC/QA PROCEDURE

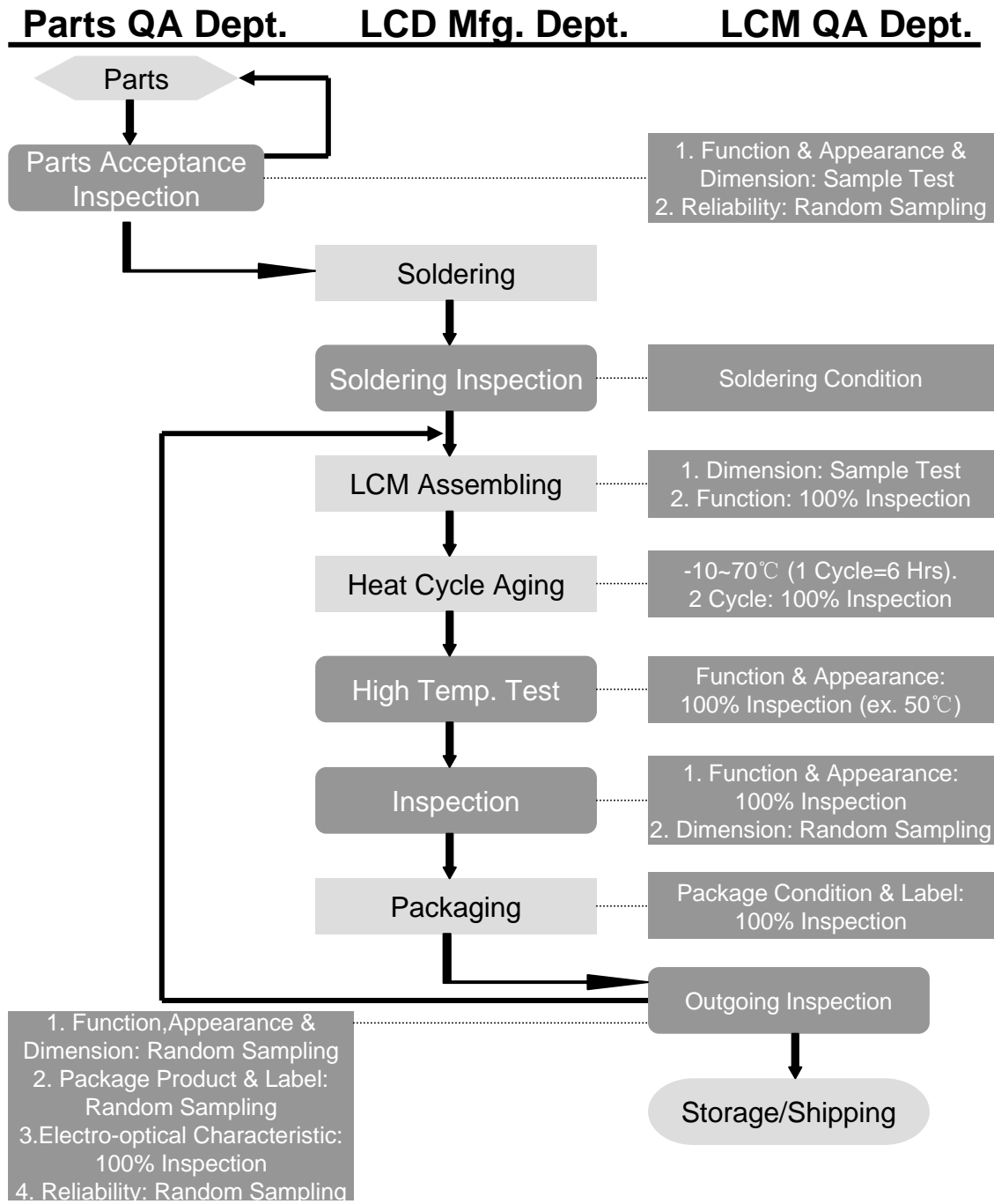

LCD MODULE SPECIFICATION FOR APPROVAL	DATE	10/12/03
	VER.	1.0
JHD12864E	PAGE	6

## 7. RELIABILITY

### •Operating life time:

Longer than 50000 hours (at room temperature without direct irradiation of sunlight)

### •Reliability Characteristics:

Item	Test	Criterion
High temp	70°C / 200 Hrs	■Total current consumption should be below double of initial value ■Contrast ratio should be within initial value±50% ■No defect in cosmetic and operational function is allowable
Low temp.	-20°C / 200 Hrs	
High humidity	40°C * 90%RH / 200 Hrs	
Thermal shock	-20°C→25°C→70°C→25°C /5 Cycles (30min) (5min) (30min) (5min)	
Vibration	1. Operating time: Thirty minutes exposure in each direction (x, y, z) 2. Sweep Frequency (1min):10Hz→ 55Hz→10Hz 3. Amplitude: 0.75mm double amplitude	

LCD MODULE SPECIFICATION FOR APPROVAL	DATE	10/12/03
	VER.	1.0
JHD12864E	PAGE	7

## 8. BLOCK DIAGRAM

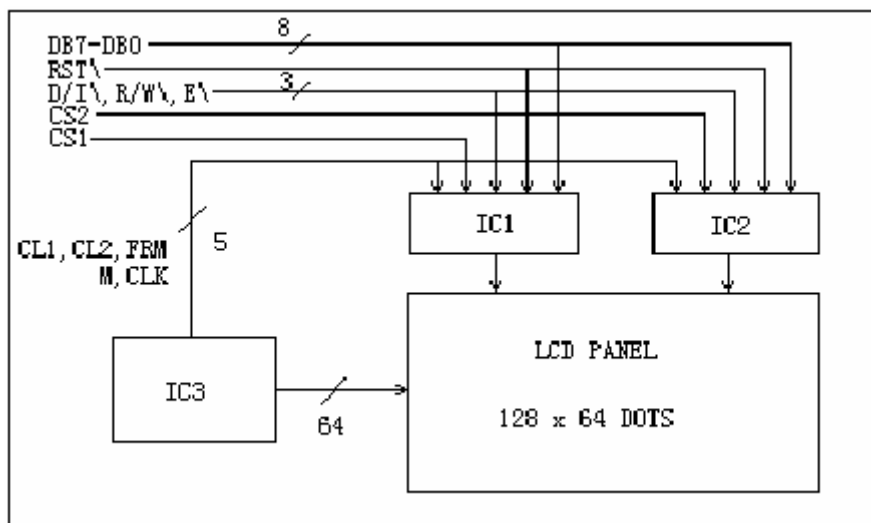

## 9. POWER SUPPLY

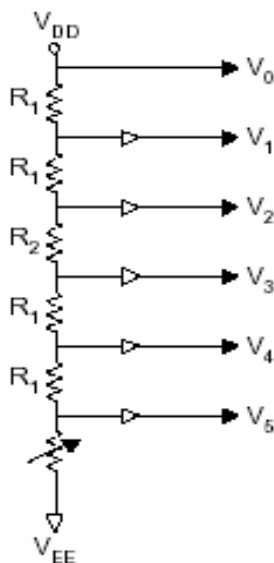

LCD MOUDULE SPECIFICATION FOR APPROVAL	DATE	10/12/03
	VER.	1.0
JHD12864E	PAGE	8

## 10. TIMING DIAGRAM

- WRITE OPERATION

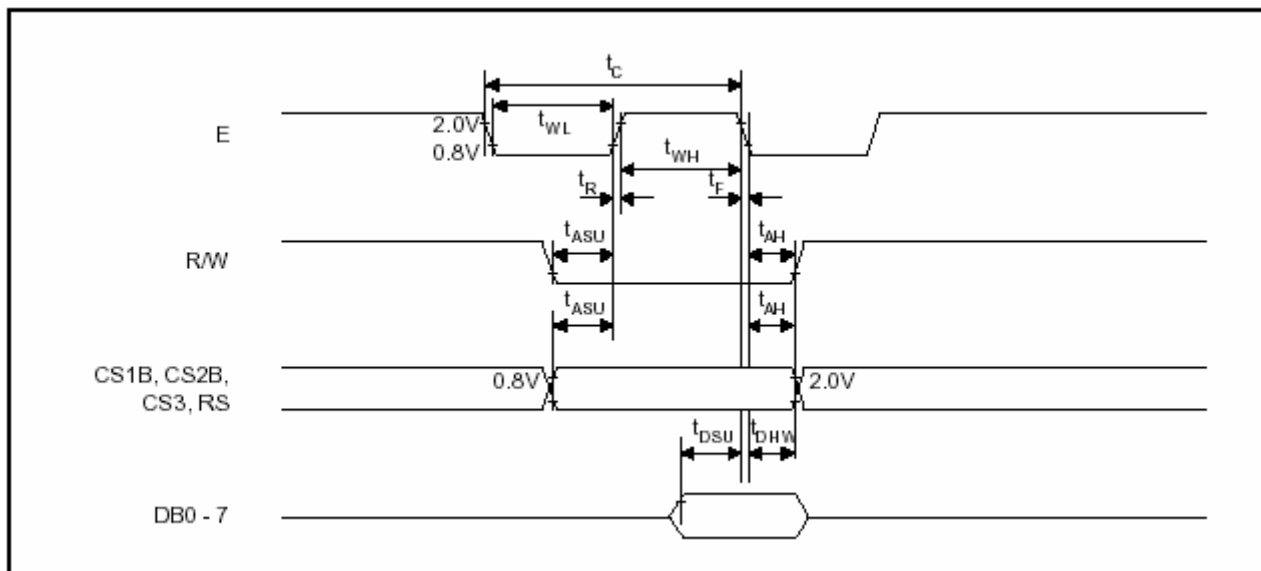

- READ OPERATION

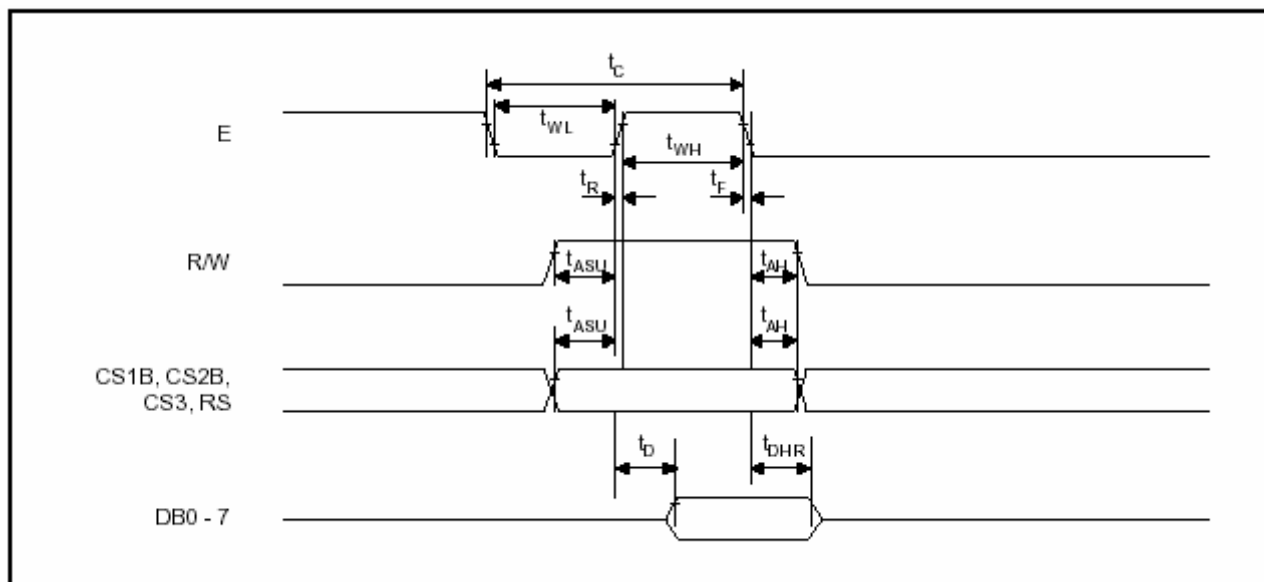



LCD MODULE SPECIFICATION FOR APPROVAL	DATE	10/12/03
	VER.	1.0
JHD12864E	PAGE	9

## 11. AC CHARACTERISTICS

### MPU Interface

Characteristic	Symbol	Min	Typ	Max	Unit
E cycle	$t_C$	1000	–	–	ns
E high level width	$t_{WH}$	450	–	–	ns
E low level width	$t_{WL}$	450	–	–	ns
E rise time	$t_R$	–	–	25	ns
E fall time	$t_F$	–	–	25	ns
Address set-up time	$t_{ASU}$	140	–	–	ns
Address hold time	$t_{AH}$	10	–	–	ns
Data set-up time	$t_{DSU}$	200	–	–	ns
Data delay time	$t_D$	–	–	320	ns
Data hold time (write)	$t_{DHW}$	10	–	–	ns
Data hold time (read)	$t_{DHR}$	20	–	–	ns

LCD MOUDULE SPECIFICATION FOR APPROVAL	DATE	10/12/03
	VER.	1.0
JHD12864E	PAGE	10

## 12. INSTRUCTION SET

### DISPLAY CONTROL INSTRUCTION

The display control instructions control the internal state of the S6B0108. Instruction is received from MPU to S6B0108 for the display control. The following table shows various instructions.

Instruction	RS	R/W	DB7	DB6	DB5	DB4	DB3	DB2	DB1	DB0	Function	
Display on/off	L	L	L	L	H	H	H	H	H	L/H	Controls the display on or off. Internal status and display RAM data is not affected. L: OFF, H: ON	
Set address (Y address)	L	L	L	H	Y address (0 - 63)						Sets the Y address in the Y address counter.	
Set page (X address)	L	L	H	L	H	H	H	Page (0 - 7)			Sets the X address at the X address register.	
Display start line (Z address)	L	L	H	H	Display start line (0 - 63)						Indicates the display data RAM displayed at the top of the screen.	
Status read	L	H	Busy	L	On/Off	Reset	L	L	L	L	Read status. BUSY L: Ready H: In operation ON/OFF L: Display ON H: Display OFF RESET L: Normal H: Reset	
Write display data	H	L	Write data									Writes data (DB0:7) into display data RAM. After writing instruction, Y address is increased by 1 automatically.
Read display data	H	H	Read data									Reads data (DB0:7) from display data RAM to the data bus.

LCD MODULE SPECIFICATION FOR APPROVAL	DATE	10/12/03
	VER.	1.0
JHD12864E	PAGE	11

## 13. Handling Precautions

### 1. Limitation of Application:

Optrex products are designed for use in ordinary electronic devices such as business machines, telecommunications equipment, measurement devices and etc. Please handle the products with care. (see below)

Optrex products are not designed, intended, or authorized for use in any application which the failure of the product could result in a situation where personal injury or death may occur. These applications include, but are not limited to, life-sustaining equipment, nuclear control devices, aerospace equipment, devices related to hazardous or flammable materials, etc. [If Buyer intends to purchase or use the Optrex Products for such unintended or unauthorized applications, Buyer must secure prior written consent to such use by a responsible officer of Optrex Corporation.] Should Buyer purchase or use Optrex Products for any such unintended or unauthorized application [without such consent], Buyer shall indemnify and hold Optrex and its officers, employees, subsidiaries, affiliates and distributors harmless against all claims, costs, damages and expenses, and reasonable attorney's fees, arising out of, directly or indirectly, any claim of personal injury or death associated with such unintended or unauthorized use, even if such claim alleges that Optrex was negligent regarding the design or manufacture of the part.

### 2. Industrial Rights and Patents

Optrex shall not be responsible for any infringement of industrial property rights of third parties in any country arising out of the application or use of Optrex products, except which directly concern the structure or production of such products.

#### No Press and Shock!

If pressure to LCD, orientation may be disturbed.  
LCD will broken by shock!

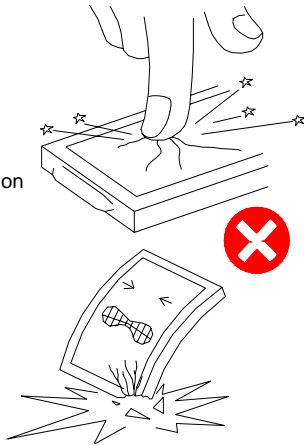

#### Don't Swallow or Touch Liquid Crystal!

Liquid Crystal may be leaked when display is broken.  
If it accidentally gets your hands, wash then with water!

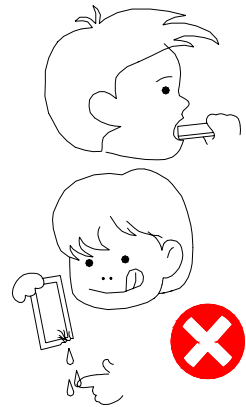

#### Don't not Scratch!

Polarizer is a soft material and can easily be scratched.

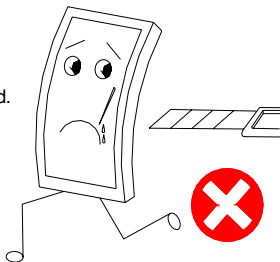

#### No DC Voltage to LCD!

DC voltage or driving higher than the specified voltage will reduce the lifetime of the LCD.

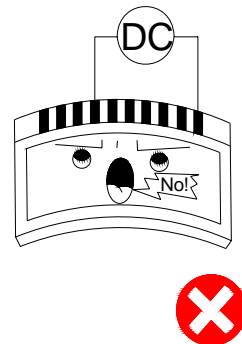

LCD MODULE SPECIFICATION FOR APPROVAL	DATE	10/12/03
	VER.	1.0
JHD12864E	PAGE	12

### Don't Press the Metallic Frame and Disassemble the LCM

Pressure on the metallic frame and PCB may deform the conductive rubber or break the liquid crystal cell and back light, which will cause defects.

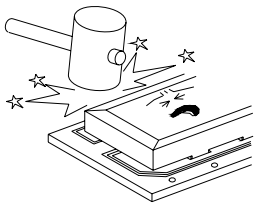

LCD may be shifted or conductive rubber may be reshaped, which will cause defects.

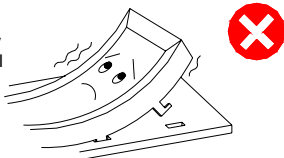

### Slowly Peel Off Protective Film!

Avoid static electricity.

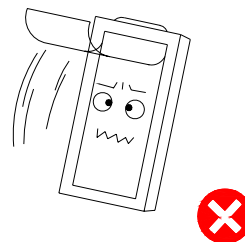

### Avoid Static Electricity!

Please be sure to ground human body and electric appliances during work. It is preferable to use conductive mat on table and wear cotton clothes or conduction processed fiber. Synthetic fiber is not recommended.

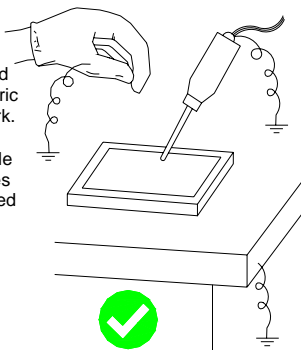

### Wear Gloves While Handling!

It is preferable to wear gloves to avoid damaging the LCD.

Please do not touch electrodes with bare hands or make them dirty.

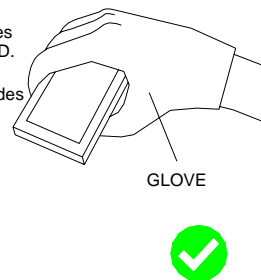

### Keep Away From Extreme Heat and Humidity!

LCD deteriorates.

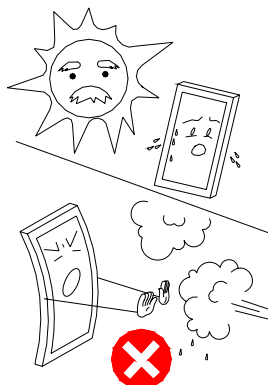

### Use Alcohol to Clean Terminals!

When attaching with the heat seal or anisotropically conductive film, wipe off with alcohol before use.

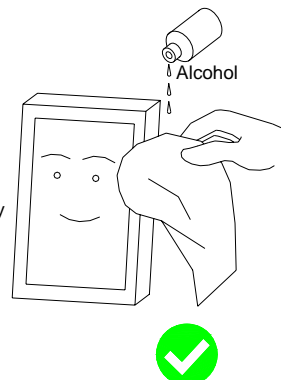

LCD MODULE SPECIFICATION FOR APPROVAL	DATE	10/12/03
	VER.	1.0
JHD12864E	PAGE	13

## Don't Drop Water on LCD!

Note that the presence of waterdrops or dew in the LCD panel may deteriorate the polarizer or corrode electrode.

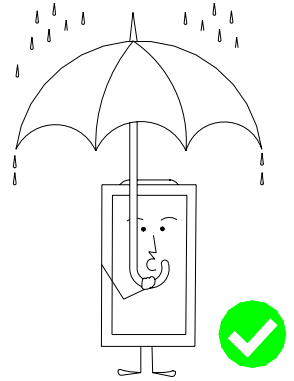

## Precaution in Soldering LCD Module

Basic instructions: Solder I/O terminals only.

Use soldering iron without leakage.

(1) Soldering condition to I/O terminals

Temperature at tip of the iron:  $280 \pm 10^\circ\text{C}$

Soldering time: 3~4 sec.

Type of solder: Eutectic solder (containing colophony-flux)

\*Please do not use flux because it may soak into LCD Module or contaminate it.

\*It is preferable to peel off protective film on display surface after soldering I/O terminals is finished.

(2) Remove connector or cable

\*When you remove connector or cable soldered to I/O terminals, please confirm that solder is fully melted. If you remove by force, electrodes at I/O terminals may be damaged (or stripped off).

\*It is recommended to use solder suction machine.

## Long-term Storage

If it is necessary to store LCD modules for a long time, please comply with the following procedures.

If storage condition is not satisfactory, display (especially polarizer) may be deteriorated or soldering I/O terminals may become difficult (some oxide is generated at I/O terminals plating).

1. Store as delivered by Optrex

2. If you store as unpacked, put in anti-static bag, seal its opening and store where it is not subjected to direct sunshine nor fluorescent lamp.

3. Store at temperature 0 to  $+35^\circ\text{C}$  and at low humidity. Please refer to our specification sheets for storage temperature range and humidity condition.

## Long-term Storage

Please use power supply with built-in surge protection circuit.

LCD MOUDULE SPECIFICATION FOR APPROVAL	DATE	10/12/03
	VER.	1.0
JHD12864E	PAGE	14

## 14. EXTERNAL DIMENSION

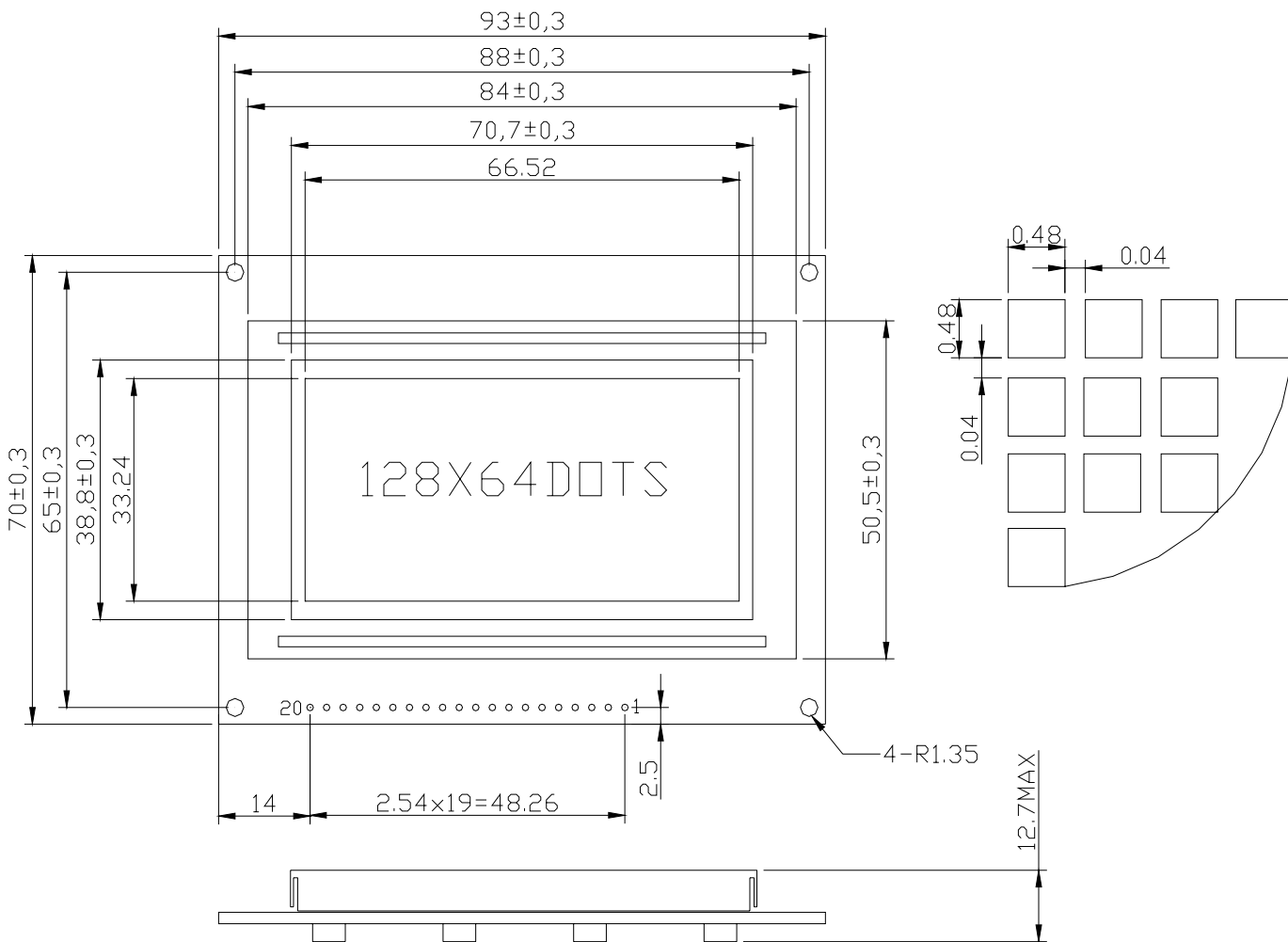

1	2	3	4	5	6	7	8	9	10
VSS	VDD	V0	D/I	R/W	E	DB0	DB1	DB2	DB3
11	12	13	14	15	16	17	18	19	20
DB4	DB5	DB6	DB7	CS1	CS2	RST	VEE	LED+	LED-

LCD MOUDULE SPECIFICATION FOR APPROVAL	DATE	10/12/03
	VER.	1.0
JHD12864E	PAGE	15

## 15. INTERFACE

PIN NO.	SYMBOL	DESCRIPTION	FUNCTION
1	VSS	GROUND	0V (GND)
2	VDD	POWER SUPPLY FOR LOGIC CIRCUIT	+5V
3	V0	LCD CONTRAST ADJUSTMENT	
4	RS	INSTRUCTION/DATA REGISTER SELECTION	RS = 0 : INSTRUCTION REGISTER RS = 1 : DATA REGISTER
5	R/W	READ/WRITE SELECTION	R/W = 0 : REGISTER WRITE R/W = 1 : REGISTER READ
6	E	ENABLE SIGNAL	
7	DB0	DATA INPUT/OUTPUT LINES	8 BIT: DB0-DB7
8	DB1		
9	DB2		
10	DB3		
11	DB4		
12	DB5		
13	DB6		
14	DB7		
15	CS1	CHIP SELECTION	CS1=1,CHIP SELECT SIGNAL FOR IC1
16	CS2	CHIP SELECTION	CS2=1,CHIP SELECT SIGNAL FOR IC2
17	RST	RESET SIGNAL	RSTB=0,DISPLAY OFF,DISPLAY FROM LINE 0.
18	VEE	NEGATIVE VOLTAGE FOR LCD DRIVING	-10V
19	LED+	SUPPLY VOLTAGE FOR LED+	+5V
20	LED-	SUPPLY VOLTAGE FOR LED-	0V